

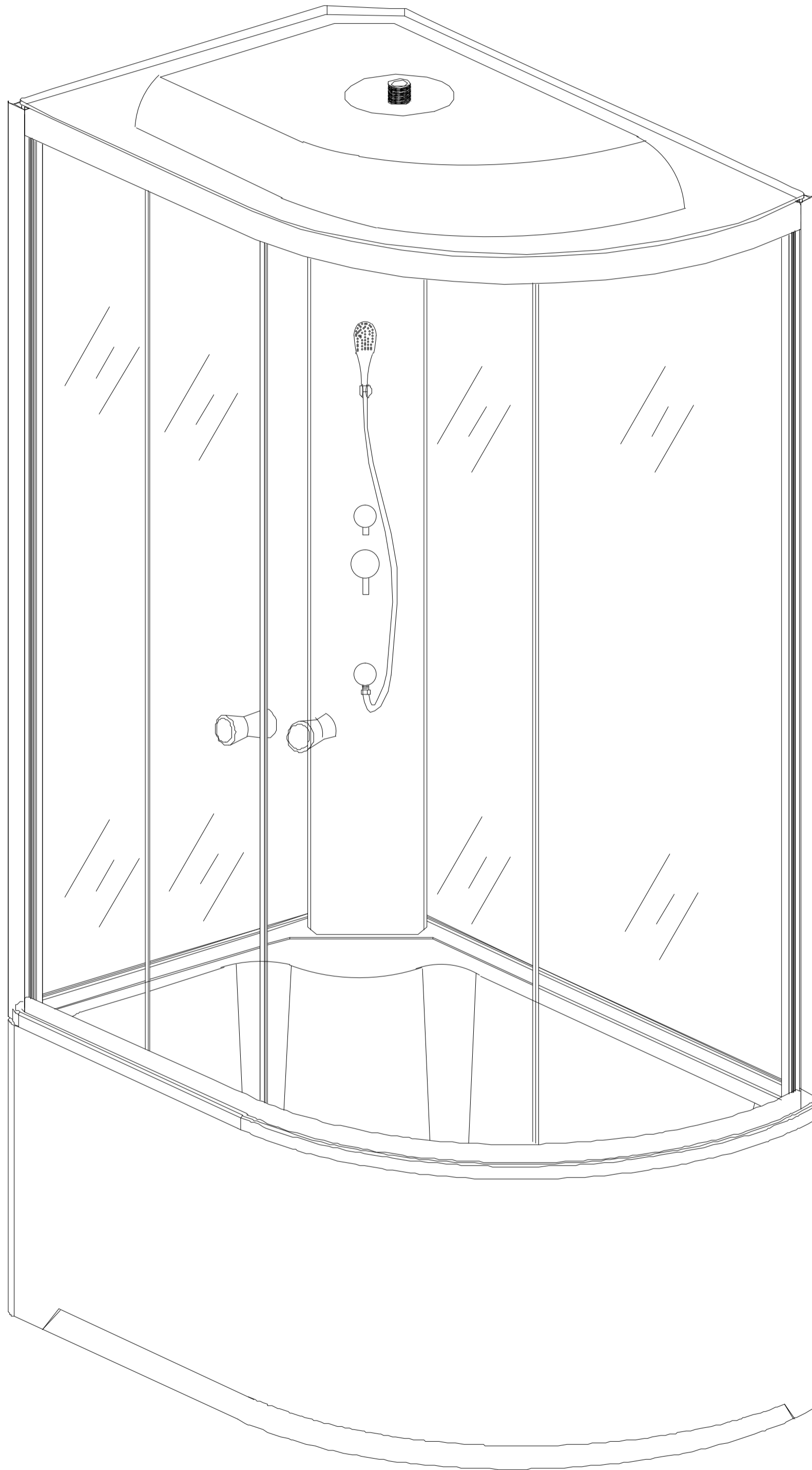

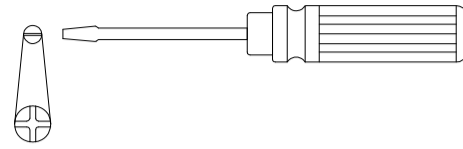

# L720L/R

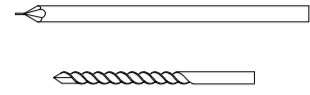

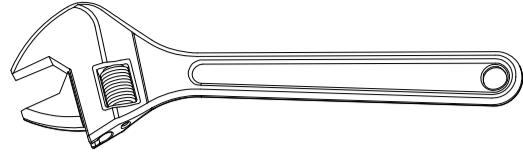
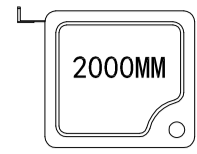
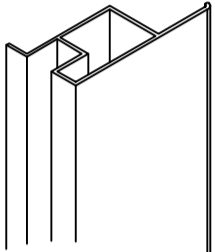
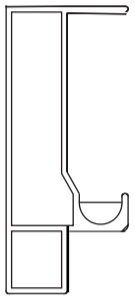
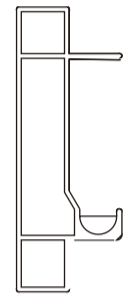
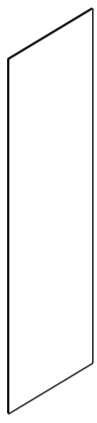
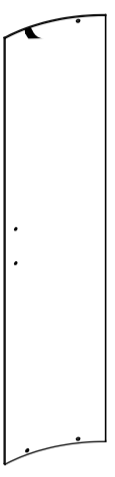
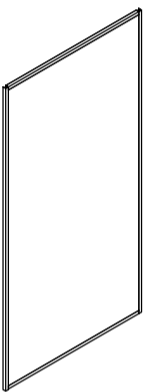
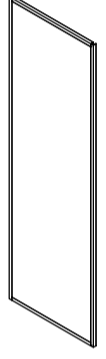
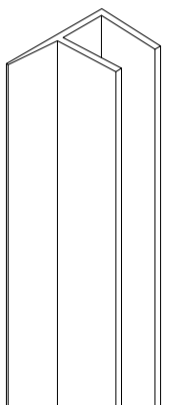
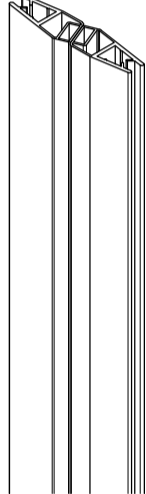
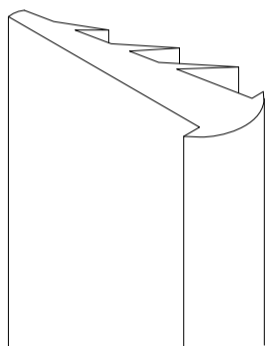
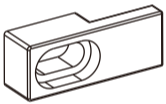
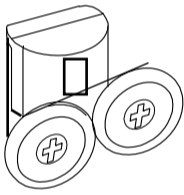
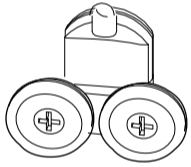
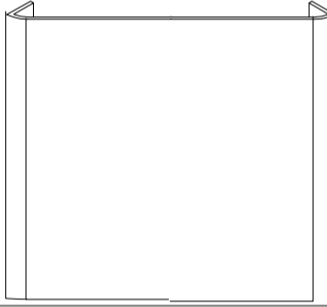
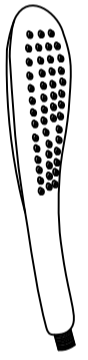
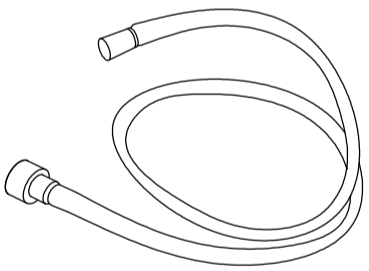

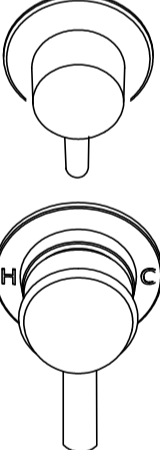
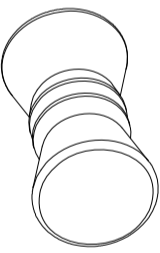
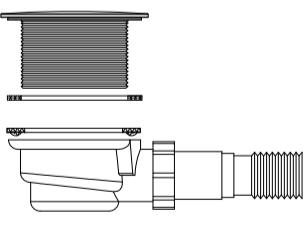
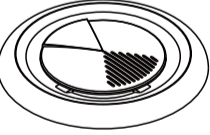
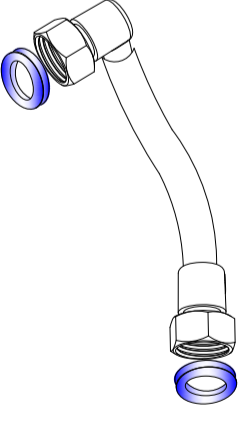
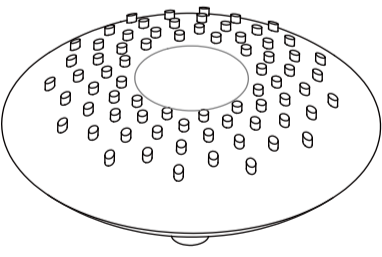
<p><b>A1</b></p>  <p>X2</p>	<p><b>A2</b></p>  <p>X1</p>	<p><b>A3</b></p>  <p>X1</p>	<p><b>A4</b></p>  <p>X2</p>	<p><b>A5</b></p>  <p>X2</p>
<p><b>A6</b></p>  <p>X1</p>	<p><b>A7</b></p>  <p>X1</p>	<p><b>A8</b></p>  <p>X4</p>	<p><b>A9</b></p>  <p>X1</p>	<p><b>A10</b></p>  <p>X2</p>
<p><b>A11</b></p>  <p>X4</p>	<p><b>A12</b></p>  <p>X4</p>	<p><b>A13</b></p>  <p>X4</p>	<p><b>A14</b></p>  <p>X1</p>	<p><b>A15</b></p>  <p>X1</p>
<p><b>A16</b></p>  <p>X1</p>	<p><b>A17</b></p>  <p>X1</p>	<p><b>A18</b></p>  <p>X1</p>	<p><b>A19</b></p>  <p>X1</p>	<p><b>A20</b></p>  <p>X2</p>
<p><b>A21</b></p>  <p>X1</p>	<p><b>A22</b></p>  <p>X2</p>	<p><b>A23</b></p>  <p>X2</p>	<p><b>A24</b></p>  <p>X1</p>	<p><b>A25</b></p>  <p>X4</p>
<p><b>ST4X12=4</b></p>  <p><b>M4X25=2</b></p> 	<p><b>ST4X50=8</b></p> <p><b>ST4X12=8</b></p> <p><b>ST4X10=32</b></p> 			

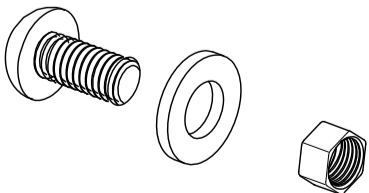
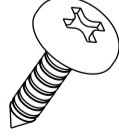
L1=215MM=4  
L2=180MM=1  
L3=80MM=1

ST4X35=8

M12=14

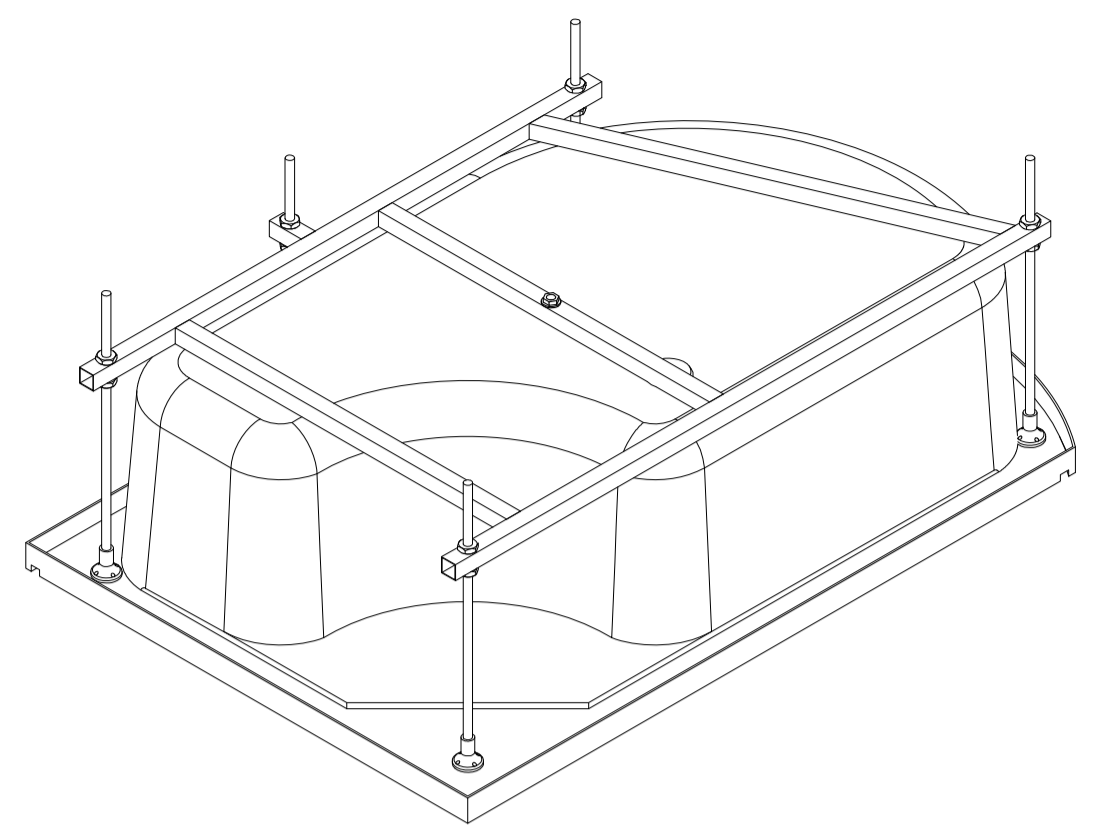
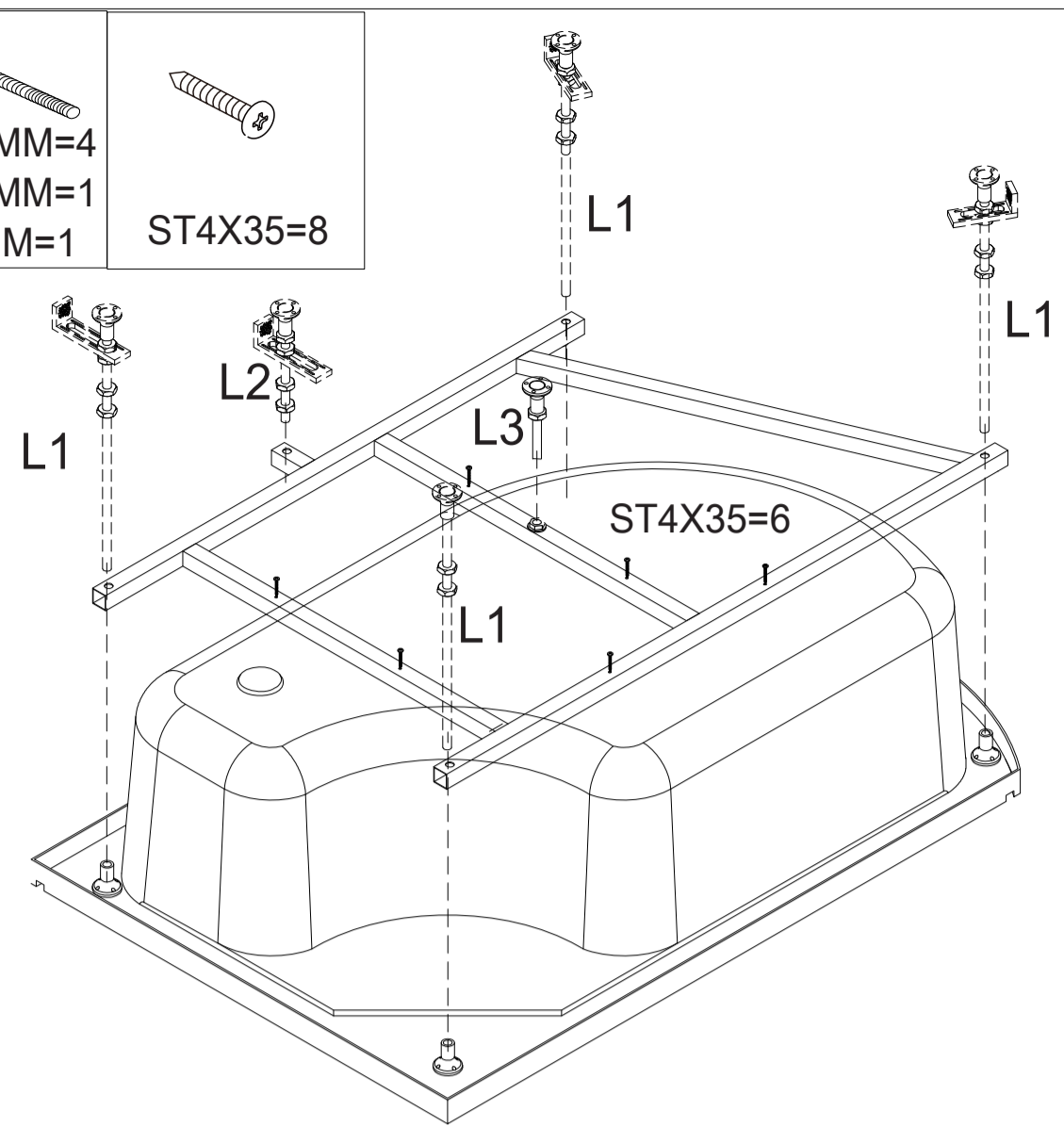

M12=15  
M12=8  
X6  
X4

X5

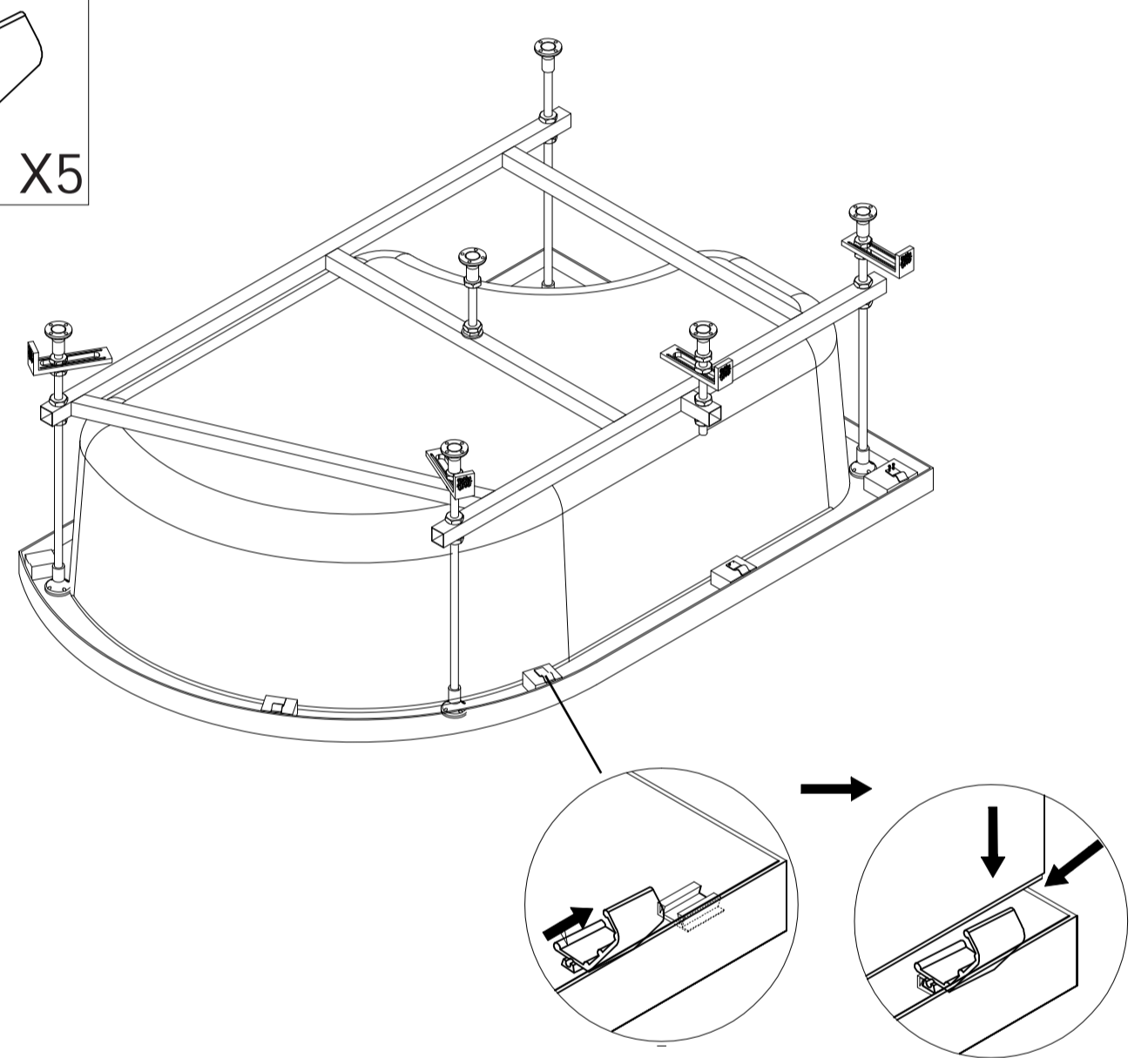
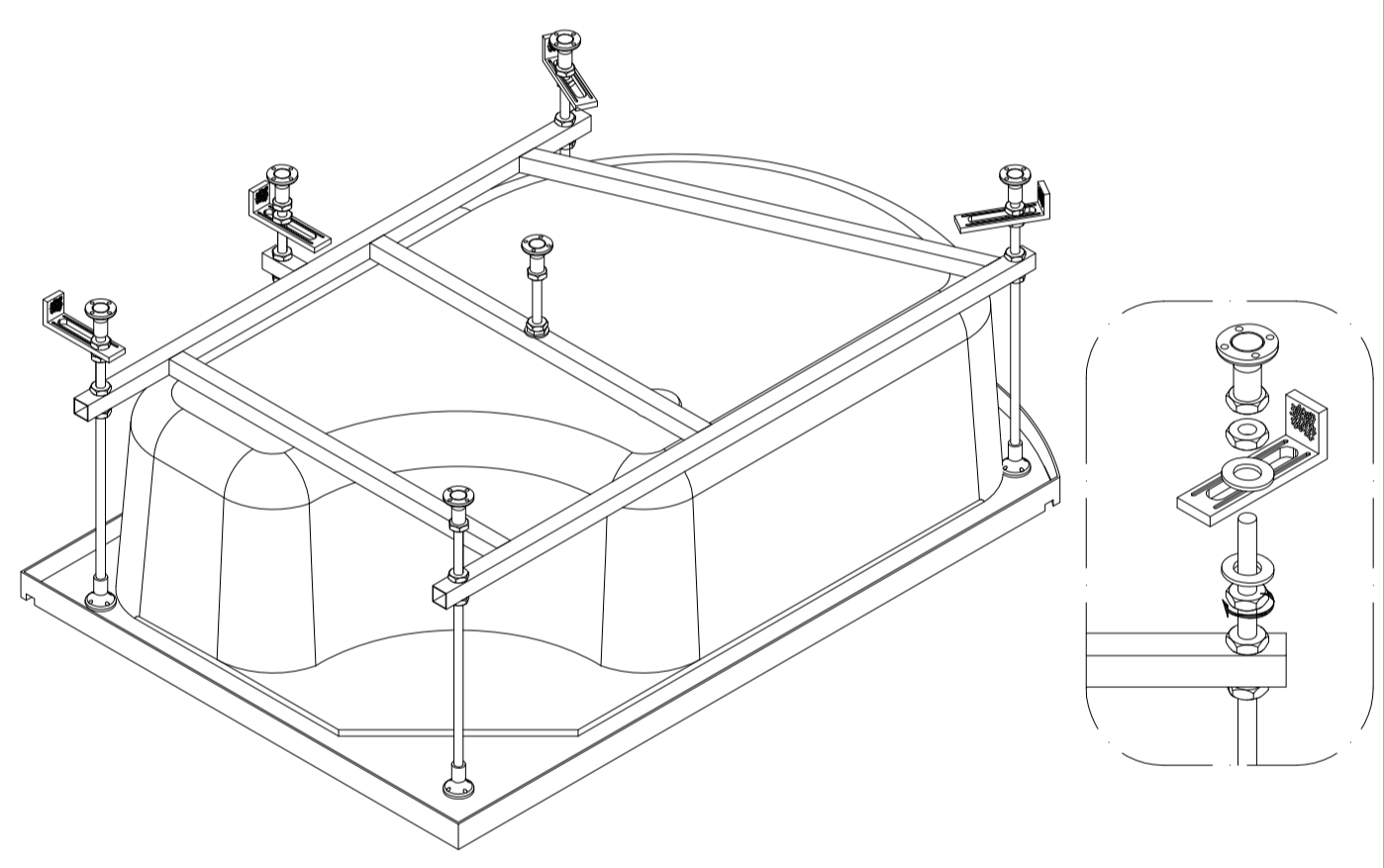

ST4X16=4

A21

