

PREDINSTALACIJA  
PREDINSTALACIJA

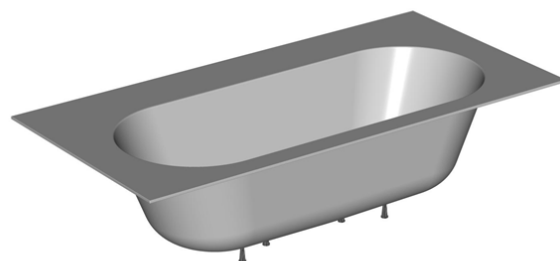
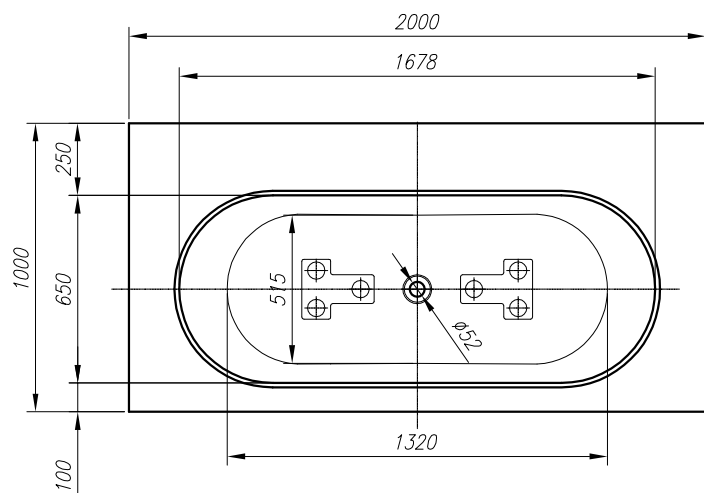
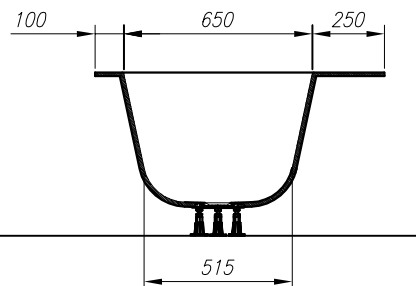
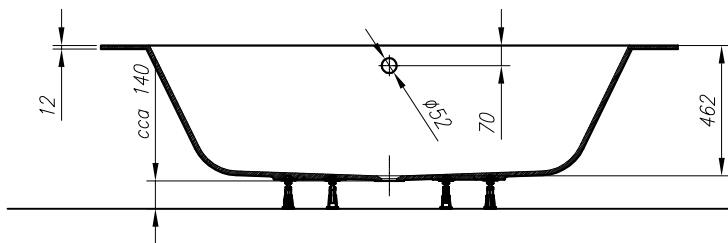
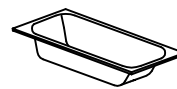

VOLUMEN (l)  
VOLUMEN (l)

MAX. OBREMNITEV (Kg)  
MAX. OBTEREČENJE (Kg)

OBREMNITEV TAL (Kg/m<sup>2</sup>)  
OBTEREČENJE PODA (Kg/m<sup>2</sup>)

225

410

300

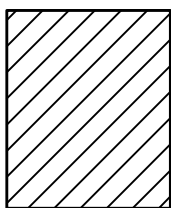

- Prostor za odtok  $\varnothing$  50 mm
- Mjesto za odtok  $\varnothing$  50 mm

- Prostor za priključak tople in hladne vode 1/2" min 0,2 Mpa, max 0,4 Mpa
- Mjesto za priključak tople i hladne vode 1/2" min 0,2 Mpa, max 0,4 Mpa

PREDLOG VGRADNJE  
PRIJEDLOG UGRADNJE

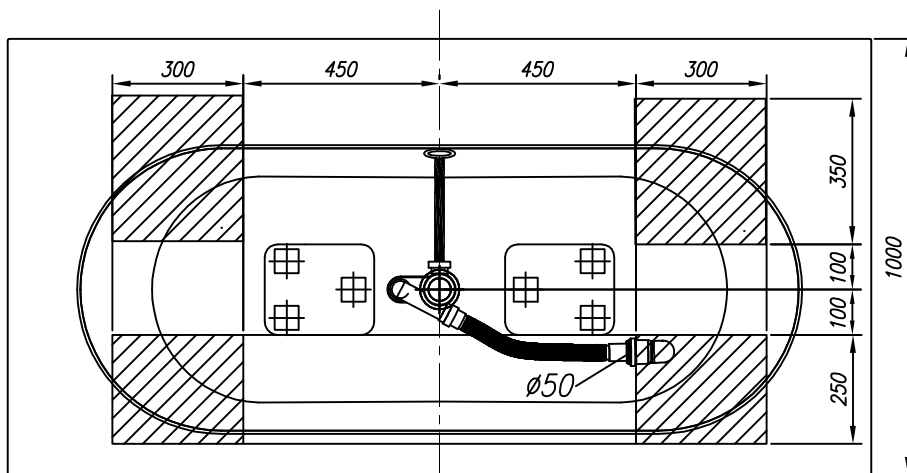

Kopalna kad iz KERROCK-a,  
Kada za kupanje iz KERROCK-a