

VOLUMEN (l)
VOLUMEN (l)

MAX. OBREMENITEV (kg)
MAX. OBTEREČENJE (kg)

OBREMENITEV TAL (kg/m²)
OBTEREČENJE PODA (kg/m²)

220

380



290

- – Prostor za el. vodnik 3 x 2,5 mm², dolžine cca 1m.
- Mjesto za el. vodnik 3 x 2,5 mm², dužine cca 1m.
- – Prostor za el. vodnik 1 x 6 mm² za ozemljitev, dolžine cca 1,5m.
- Mjesto za el. vodnik 1 x 6 mm² za ozemljenje, dužine cca 1,5m.
- – Prostor za odtok \varnothing 50 mm
- Mjesto za odtok \varnothing 50 mm
- ▨ – Opcija-obloga
- Opcija-obloga

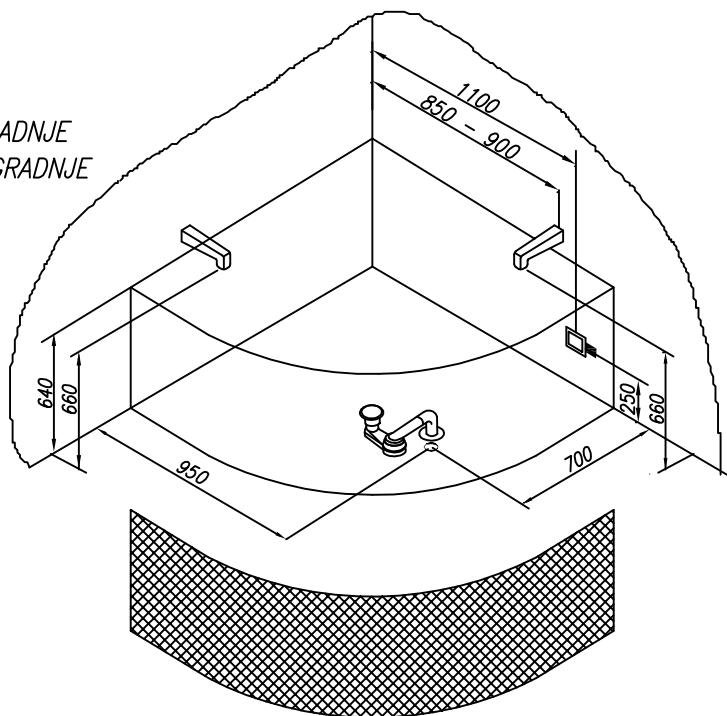
PREDLOG VGRADNJE
PRIJEDLOG UGRADNJE



Priporočena prelivna garnitura Preporuka prelivne garniture	PAL 450
Priporočila za vgradnjo kadi brez obloge Preporuka za ugradnjo kade bez obloge	Nr. MK 02
Priporočila za montažo kadi z oblogo Preporuka za ugradnjo kade sa oblogom	Nr. MK 01
Opcija podnožja kadi za vgradnjo Varianta postolja za kade bez obloge	Nr. MK 07 1001/L
Opcija podnožja kadi z oblogo Varianta postolja za kade sa oblogom	Nr. MK 17 CKM 120-150

- | | | | | |
|--|--|---|--|--|
|  - VODNA ČRPALKA
- CRPKA ZA VODU |  - VODNE ŠOBE
- VODENE MLAZNICE |  - REGULATOR ZRAKA
- REGULATOR ZRAKA |  - ELEKTRONSKA STIKALA
- ELEKTRONSKI PREKIDAČI |  - ARMATURA IN TUŠ ROČICA
- PIPA I TUŠ |
|  - ZRAČNI KOMPRESOR
- ZRAČNI KOMPRESOR |  - ZRAČNA ŠOBA
- ZRAČNA MLAZNICA |  - PNEVMATSKO STIKALO
- PNEVMATSKI PREKIDAČ |  - LUČ ALI CHROMOTERAPIJA
- SVJETLO ILI CHROMOTERAPIJA |  - PREKLOPNIK ZA MIKROŠOBE
- PREKIDAČ ZA MIKROMLAZNICE |

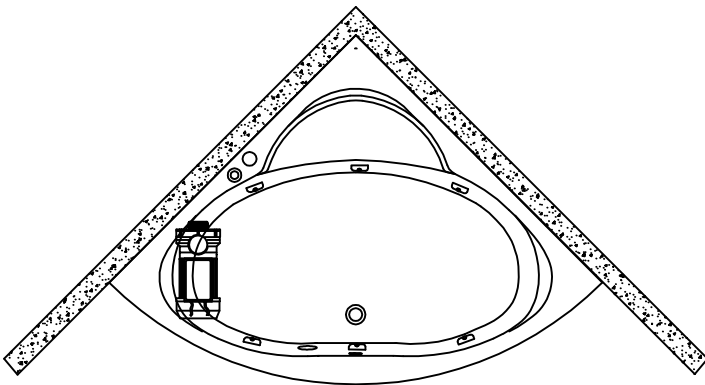

VODNI MASAŽNI SISTEM 1

- VODNA ČRPALKA P= 800W
- PNEVMATSKO STIKALO
- 6 VODNIH ŠOB
- REGULATOR ZRAKA

VODNI MASAŽNI SISTEM 1

- CRPKA ZA VODU P= 800W
- PNEVMATSKI PREKIDAČ
- 6 MLAZNICA ZA VODU
- REGULATOR ZRAKA

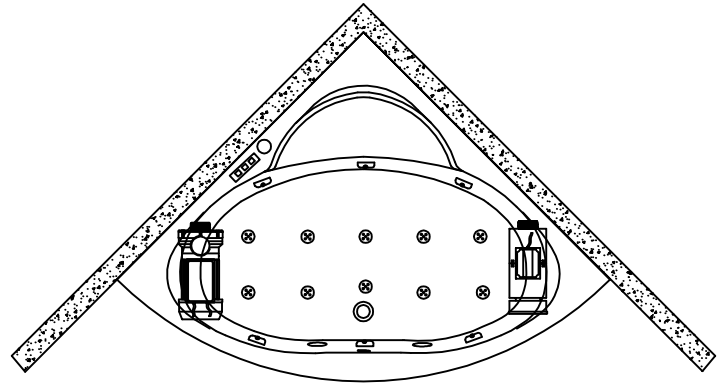





VODNI IN ZRAČNI
MASAŽNI SISTEM

- VODNA ČRPALKA P= 800W
- ZRAČNI KOMPRESOR P=800W
- ELEKTRONSKO STIKALO
- 6 SUPER VODNIH ŠOB
- 10 ZRAČNIH ŠOB
- REGULATOR ZRAKA

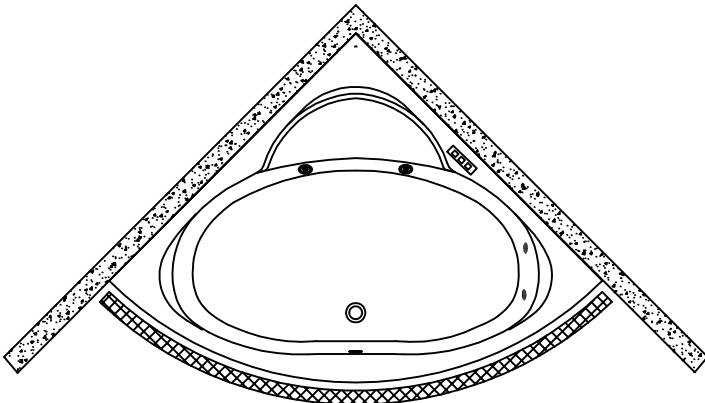
VODNI I ZRAČNI
MASAŽNI SISTEM

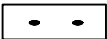
- CRPKA ZA VODU P= 800W
- ZRAČNI KOMPRESOR P=800W
- ELEKTRONSKI PREKIDAČ
- 6 SUPER MLAZNICA ZA VODU
- 10 ZRAČNIH MLAZNICA
- REGULATOR ZRAKA

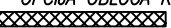

- | | |
|--|--|
| - OPCIJA DVE DODATNI MIKRO ŠOBI
 | - OPCIJA DVJE DODATNE MIKROMLAZNICE
 |
| - OPCIJA CHROMOTERAPIJA
 | - OPCIJA CHROMOTERAPIJA
 |
| - OPCIJA OBLOGA KADI
 | - OPCIJA OBLOGA KADE
 |